

HS-300B-PLUS C Technical Data Sheet

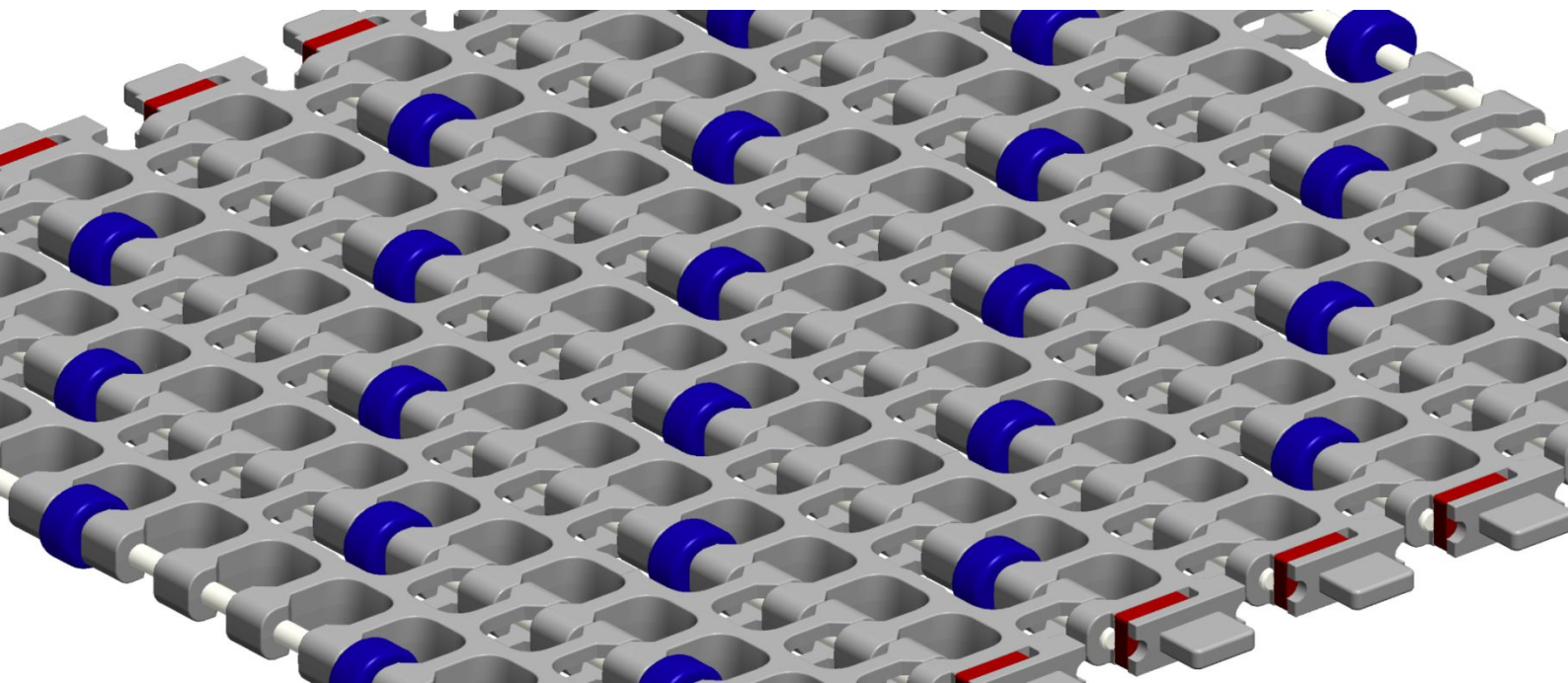

Pitch: 45mm Minimum Width: 240mm Open Area: 52% Approved: FDA Rod: Ø 6mm Flight: No Side Guard: No Curve: Yes	
--	--

Data

Belt Material	Belt Strength				Temperature		Belt Weight (Kg/M ²)
	Straight		Curve		°C (min.)	°C (max.)	
	Kg/M(BW)	N/M(BW)	Kg/M(BW)	N/M(BW)			
Polypropylene	1870	18700	1420	14200	1	100	6.4
Polyethylene	1330	13300	820	8200	-60	60	6.9
Acetal	2900	29000	1420	14200	-40	80	9.6
Nylon	1870	18700	820	8200	1	180	8.8

BW – Belt Width

Color Table

Polypropylene					Polyethylene					Acetal					Nylon				
W	G	N	DB	B	W	G	N	DB	B	W	G	N	DB	B	W	G	N	DB	B
●	●						●			●				●				●	

W-White, G-Gray, N-Nature, DB-Dark brown, B-Blue

Friction Table

Belt Material	Friction Wear strips & Products							
	UHMW	HDPE	Steel	Glass	SUS	Plastic	Cardboard	Aluminum
Polypropylene	0.32	0.24	0.15	0.09	0.13	0.08	0.15	0.25
Polyethylene	0.13	0.11	0.26	0.19	0.31	0.16	0.21	0.41
Acetal	0.11	0.09	0.27	0.16	0.26	0.15	0.19	0.28
Nylon	0.18	0.13	0.25	0.16	0.26	0.16	0.19	0.27

SUS – Stainless Steel

Equivalent type with other Brand

Brand Name	Intralox	UNI	Rexnord	MCC	Habasit	KVP
Series & Type	2200	Flex-SNB	1200		2500	610
			7956		3800	

The above content is only for reference.

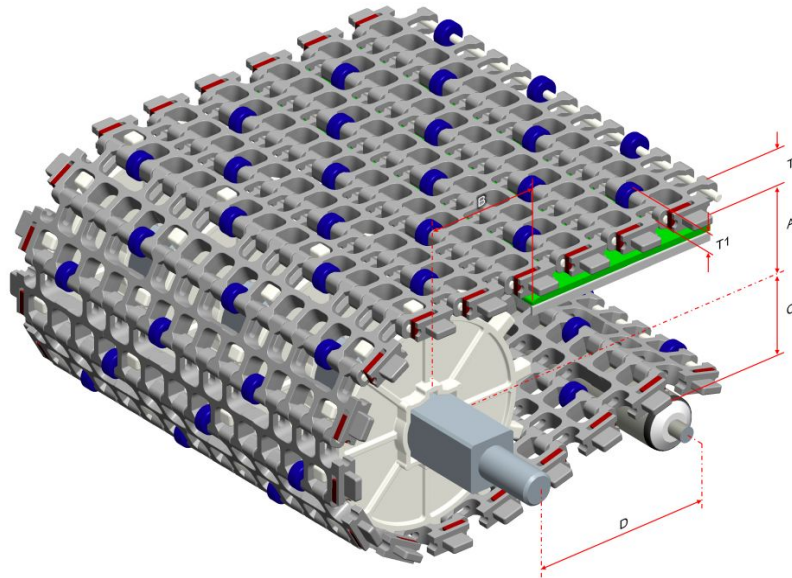

Conveyor Frame Dimensions						Unit : mm
No. Teeth	A (Min.)	B (Min.)	C (Max.)	D (Min.)	T	T1
8	51	62	63	300	15	4.5
12	80	82	94	300		

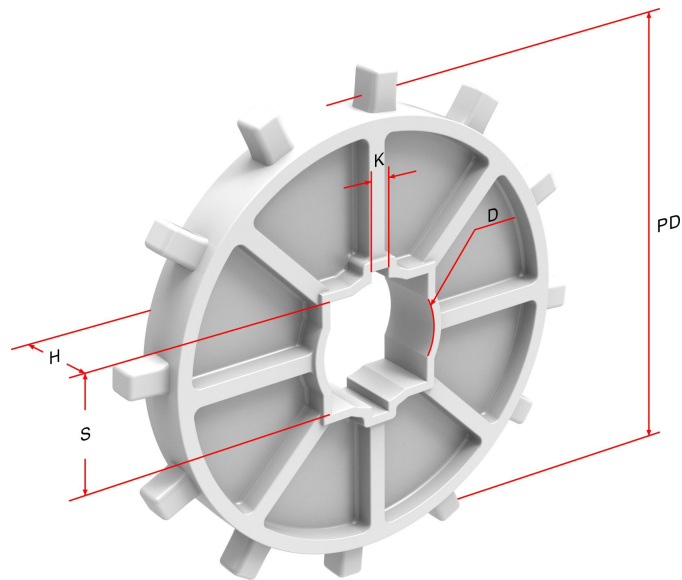

Sprocket Dimensions						Unit: mm
No. Teeth	PD	S	D	H	K	
8	120	40.5	45.5	12	6X6	
12	185	40.5	45.5	24	6X6	

Design Guide Summary

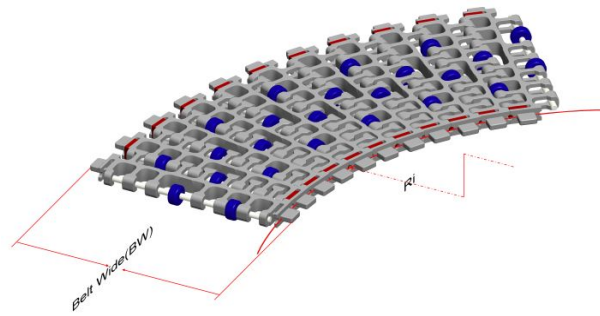

- The minimum turning radius (inside) is 2.2 times of belt width under all feasible belt Width, 2.5 times of belt width is the most optimal.
- The minimum straight run section near driving shaft and idling shaft of Radius belt must be 2 times of the belt width in length.
- The minimum straight run section between two turns of opposing direction must be 2 times of the belt width in Length.

Guide Rail & Wear Strips

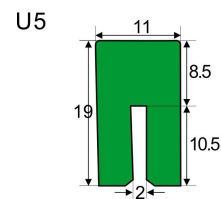
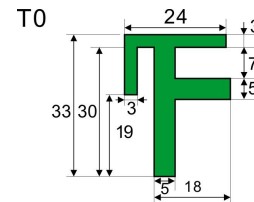
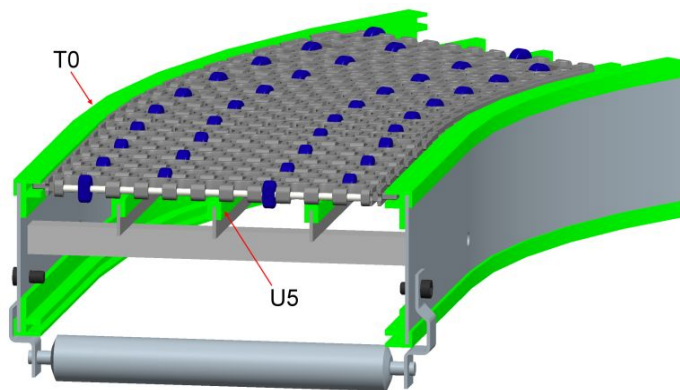

- We have different kinds of guide rail and wear strips for your choice; For more information, please consult our sales team.

Support Mode of Insert Roller

- **Accumulation**

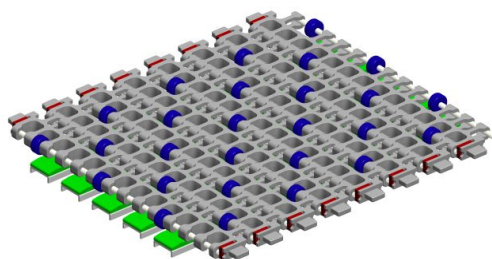

Wear Strips are placed between rollers for accumulation.

- **Multi-Speed**

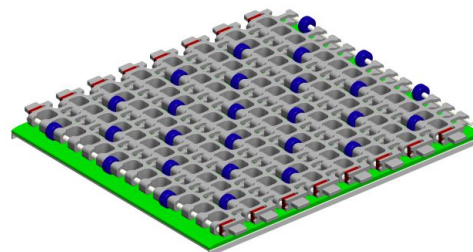

Wear Strips are placed under the rollers and the speed of products on the belt will be 2 times of the belt speed.